

AUTOMOTIVE TOOLS
WERKZEUGE FÜR KFZ UND NUTZFAHRZEUGE
OUTILS POUR POIDS LOURDS ET VÉHICULES UTILITAIRES

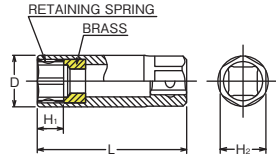

Z-SERIES
 HAND
 TITANIUM
 SCREWDRIVERS ACCESSORIES
 IMPACT
 SLEEVE-DRIVE
 PROTECTOR
 INDUSTRIAL
 AUTOMOTIVE
 MOTORCYCLE
 CONSTRUCTION
 SPARE PART

3300C / 4300C Spark Plug Sockets with Spring Clips
 Zündkerzen-Schlüssel mit Haltefeder
 Douille avec ressorts de retenue pour bougies



3300C (mm)		D (mm)	H ₁ (mm)	H ₂ (mm)	L (mm)	(g)	(pcs.)
13		17.5	11	17	70	66	10
14	3/8"	19	11	17	70	82	10
16		20.5	13	17	70	91	10
18		23.9	12	21	70	140	10
20.8		26.9	13.5	22	70	132	10

4300C (mm)		D (mm)	H ₁ (mm)	H ₂ (mm)	L (mm)	(g)	(pcs.)
16	1/2"	21	13	21	70	101	10
18		23.9	12	21	70	132	10
20.8		26.9	13.5	22	70	130	10

Spring clip type spark plug sockets caused deforming the clip if it would be used with shallow engagement.

3300CB Spark Plug Socket (BMW)
 Zündkerzen-Schlüssel (BMW)
 Douille pour bougies (BMW)

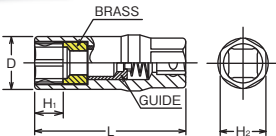

3300CB (mm)		D (mm)	H ₁ (mm)	H ₂ (mm)	L (mm)	(g)	(pcs.)
16	3/8"	22.8	13	19	65	118	10

Spring clip type spark plug sockets caused deforming the clip if it would be used with shallow engagement.

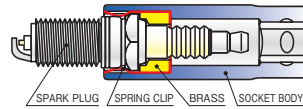

SPARK PLUG SOCKETS with SPRING CLIP
 An internal brass guide holds the clips in place, which ensures perfect alignment of the spark plug into the threaded plug hole of the cylinder head, thus preventing thread damage. The brass guide also eliminates stress loading and possible damage to the ceramic insulator of the spark plug.

3300P Spark Plug Socket with Magnet
 Zündkerzensteckschlüssel mit Magnet
 Douille pour bougies, avec aimant

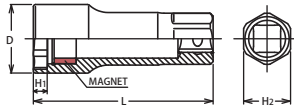

3300P (mm)		D (mm)	H ₁ (mm)	H ₂ (mm)	L (mm)	(g)	(pcs.)
New 19	3/8"	24.8	5	17	65	88	10



19mm spark plug for generators, grass trimmers and chainsaws

The magnet could be broken with any impacts. Please handle with care.

3305P Spark Plug Socket with Magnet, 12-pt. opening
 Zündkerzensteckschlüssel mit Magnet, 12-kant
 Douille pour bougies, avec aimant, 12-pans

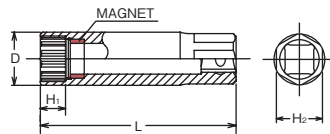

3305P (mm)		D (mm)	H ₁ (mm)	H ₂ (mm)	L (mm)	(g)	(pcs.)
New 12	3/8"	16.5	6.3	-	70	78	10
14		19	8	17	70	87	10
16		20.5	8	17	70	100	10

Spark Plug Socket with Magnet, 12-pt. opening: 3305P-14



The magnet could be broken with any impacts. Please handle with care.

3300S / 4300S Spark Plug Sockets with Rubber
 Zündkerzen-Schlüssel mit Gummiemsetz
 Douille pour bougies avec caoutchouc

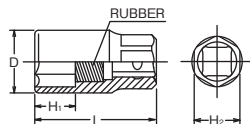

3300S (mm)		D (mm)	H ₁ (mm)	H ₂ (mm)	L (mm)	(g)	(pcs.)
16	3/8"	20.9	19	17	70	100	10
18		23.9	21	21	70	145	10
20.8		26.9	27	22	70	140	10

4300S (mm)		D (mm)	H ₁ (mm)	H ₂ (mm)	L (mm)	(g)	(pcs.)
16	1/2"	21	19	21	70	100	10
18		23.9	21	21	70	130	10
20.8		26.9	27	22	70	135	10

3300C-180 (mm)		D ₁ (mm)	D ₂ (mm)	H (mm)	L (mm)	 (g)	 (pcs.)
14	3/8"	19	18	11	180	205	5
16		20.5	18	13	180	220	5
20.8		26.9	18	13.5	180	260	5

3300C-250 (mm)		D ₁ (mm)	D ₂ (mm)	H (mm)	L (mm)	 (g)	 (pcs.)
14	3/8"	19	18	11	250	271	5
16		20.5	18	13	250	290	5
20.8		26.9	18	13.5	250	340	5

Spring clip type spark plug sockets caused deforming the clip if it would be used with shallow engagement.



3300C-180 / -250 Spark Plug Sockets with Spring Clips Zündkerzen-Schlüssel mit Haltefedern Douille avec ressorts de retenue pour bougies

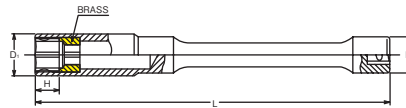

3305P-250

Spark Plug Socket with Magnet, 12pt. opening
 Zündkerzensteckschlüssel mit Magnet, 12-kant
 Douille pour bougies, avec aimant, 12-pans

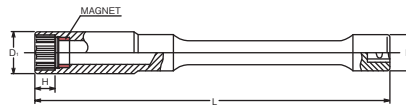

3305P-250 (mm)		D ₁ (mm)	D ₂ (mm)	H (mm)	L (mm)	 (g)	 (pcs.)
14	3/8"	19	18	8	250	250	5

The magnet could be broken with any impacts. Please handle with care.

3340C (mm)		D ₁ (mm)	D ₂ (mm)	H (mm)	L (mm)	 (g)	 (pcs.)
14	3/8"	19	19	11	88	109	10
16		21	19	13	88	122	10
18		23.9	19	12	88	145	10
20.8		26.8	19	13.5	88	174	10

4340C (mm)		D ₁ (mm)	D ₂ (mm)	H (mm)	L (mm)	 (g)	 (pcs.)
16	1/2"	21	25	13	107	220	10
20.8		26.8	25	13.5	107	250	10

Spring clip type spark plug sockets caused deforming the clip if it would be used with shallow engagement.

3340C Universal Spark Plug Sockets with Spring Clips 4340C Gelenk-Zündkerzenschlüssel mit Haltefeder Douille articulée avec ressorts de retenue pour bougies

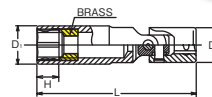

3345P Universal Spark Plug Socket with Magnet, 12-point opening Gelenk-Zündkerzensteckschlüssel mit Magnet, 12-kant Ausführung Clé pour bougies à déclenchement articulée avec aimant, 12 pans

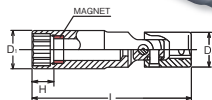

3345P (mm)		D ₁ (mm)	D ₂ (mm)	H (mm)	L (mm)	 (g)	 (pcs.)
14	3/8"	19	19	8	88	110	10

The magnet could be broken with any impacts. Please handle with care.

127C T-type Universal Spark Plug Socket Wrench T-Griff mit Gelenk-Zündkerzenschlüssel Poignée en T avec douille universelle pour bougies

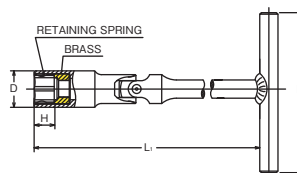
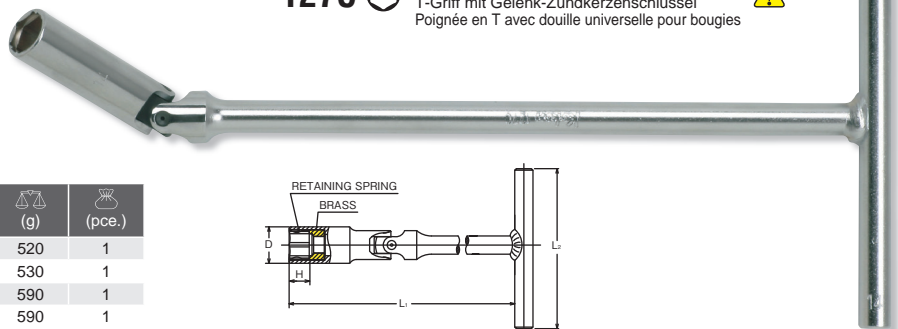

127C-315 (mm)	D (mm)	H (mm)	L ₁ (mm)	L ₂ (mm)	 (g)	 (pcs.)
14	19	11	315	150	520	1
16	21	13	315	150	530	1
18	23.9	12	315	150	590	1
20.8	26.8	13.5	315	150	590	1

Spring clip type spark plug sockets caused deforming the clip if it would be used with shallow engagement.

Z-SERIES
 HAND
 TITANIUM
 SCREWDRIVERS ACCESSORIES
 IMPACT
 SLEEVE-DRIVE
 PROTECTOR
 INDUSTRIAL
 AUTOMOTIVE
 MOTORCYCLE
 CONSTRUCTION
 SPARE PART

3751N Torque Ratchet for Spark plugs
 Drehmoment-Knarre für Zündkerzen
 Cliquet pour bougies à déclenchement 25Nm



TORQUE RATCHET

The torque is set at 25Nm. When the torque is loaded higher than 25Nm, the gear slips and no increased torque is transmitted. Cylinder heads and spark plugs are protected by this mechanism.

DREHMOMENT-KNARRE

Die Knarre ist auf ein Drehmoment von 25Nm eingestellt. Ist das Drehmoment von 25Nm erreicht, springt das innere Getriebe über. Dies schützt die Zündkerzengewinde am Zylinderkopf.

CLIQUET À DÉCLENCHEMENT

Le cliquet est fixé à un torque d'une capacité maximale de 25NM. Une fois les 25NM atteints, ce mécanisme évite tout dépassement du cliquet.

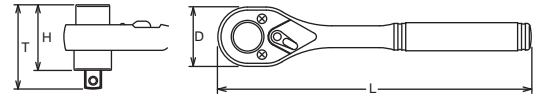

3751J Torque Ratchet for Spark plugs
 Drehmoment-Knarre für Zündkerzen
 Cliquet pour bougies à déclenchement 25Nm



		D (mm)	T (mm)	H (mm)	L (mm)	(g)	(pce.)
3751N-25		34	57	43	178	320	1
3751J-25		34	57	43	178	320	1

3225A Set for Torque Controlled Installation of Spark Plugs
 Set zur Drehmoment kontrollierten Montage von Zündkerzen
 Jeu qui permet la rotation contrôlée lors du montage des bougies à déclenchement



3225A		4 Pieces Set/△=960g	
METAL CASE:W215xH80xT47mm			
Sockets		Accessories	
	3300C Spark Plug Sockets 16, 20.8		3751J-25
			3763-125

3701-20Nm / -30Nm Torque Adaptors 20Nm / 30Nm
 Drehmoment-Verbindungsstücke 20Nm / 30Nm
 Adaptateurs dynamométriques 20Nm / 30Nm



3701		D (mm)	L (mm)	(g)	(pce.)
20Nm		25.5	75	178	1
30Nm		28	75	220	1

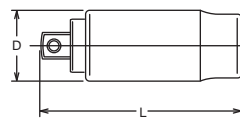

Z-SERIES
HAND
TITANIUM
ACCESSORIES
SCREWDRIVERS
IMPACT
SLEEVE-DRIVE
PROTECTOR
INDUSTRIAL
AUTOMOTIVE
MOTORCYCLE
CONSTRUCTION
SPARE PART

2350G-PSG (mm)		D ₁ (mm)	D ₂ (mm)	H ₁ (mm)	H ₂ (mm)	L (mm)	 (g)	 (pcs.)
12	1/4"	16.5	15.5	12	41	50	41	10



2350G-12PSG

NUT GRIP® Sockets for PSG-Glow Plugs
Steckschlüssel für PSG-Glühkerzen
Douille pour bougies PSG

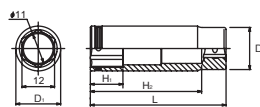

3341G-70 (mm)		D ₁ (mm)	D ₂ (mm)	H (mm)	L (mm)	 (g)	 (pcs.)
10	3/8"	14.5	19	6	70	76	10
11		15.8	19	6	70	80	10
12		17	19	6	70	85	10

3341G-70 / -89

Universal PSG Glow Plug Socket with NUT GRIP®
Gelenksteckschlüssel für PSG-Glühkerzen mit 2fach Kugelhalterung
Douille articulée pour bougies de préchauffement PSG, avec le système de billes de retenue, double.

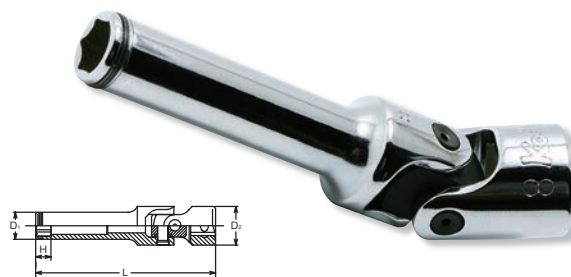

3341G-89 (mm)		D ₁ (mm)	D ₂ (mm)	H (mm)	L (mm)	 (g)	 (pcs.)
8	3/8"	12	19	7.5	89	82	10
9		13.3	19	7.5	89	87	10
10		14.5	19	6	89	92	10
12(DP52)		17	19	14	89	101	10

GLOW PLUG SOCKETS, NUT GRIP®

Twin balls at the 6-point opening hold bolt/nut tightly for safe and reliable work.

Die zwei Kugeln in der 6-kant Öffnung unserer NUT GRIP® Glühkerzensteckschlüssel halten die Zündkerze sicher im Steckschlüssel. Dies erlaubt ein Arbeiten auch an schwer zugänglichen Stellen.

Les deux billes se trouvant dans l'ouverture de notre NUT GRIP® (6 pans) pour bougies de préchauffement, maintiennent la bougie de déclenchement dans la douille. Ceci permet l'accès dans les endroits difficilement accessibles.



3342G-150

Deep length universal Glow Plug Socket
Extra langer Glühkerzen-Steckschlüssel mit Gelenk
Douille articulée pour bougies de préchauffement, extra longue

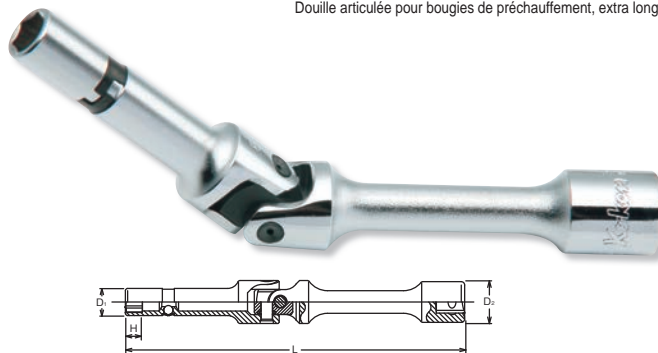

3342G-150 (mm)		D ₁ (mm)	D ₂ (mm)	H (mm)	L (mm)	 (g)	 (pcs.)
8	3/8"	12	18	7.5	150	137	10

178-10H (mm)	D (mm)	H ₁ (mm)	H ₂ (mm)	S (mm)	L (mm)	 (g)	 (pcs.)
9	13	6.5	10	6.7	50	16	10

178-10H

For Glow Plugs
Für Glühkerzen
Pour bougies de préchauffement



144KM

For Glow Plugs
Für Glühkerzen
Pour bougies de préchauffement

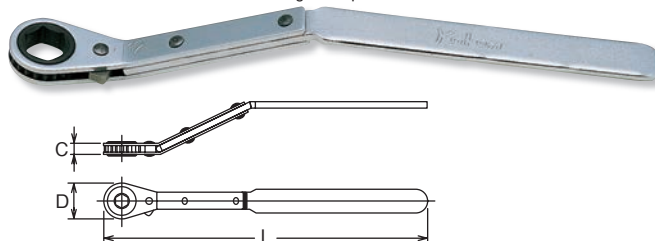

144KM (mm)	L (mm)	D ₁ (mm)	D ₂ (mm)	C (mm)	 (g)	 (pce.)
8	200	22.7	7.5	95	1	
12	200	22.7	7.5	102	1	

148KM

For Glow Plugs
Für Glühkerzen
Pour bougies de préchauffement

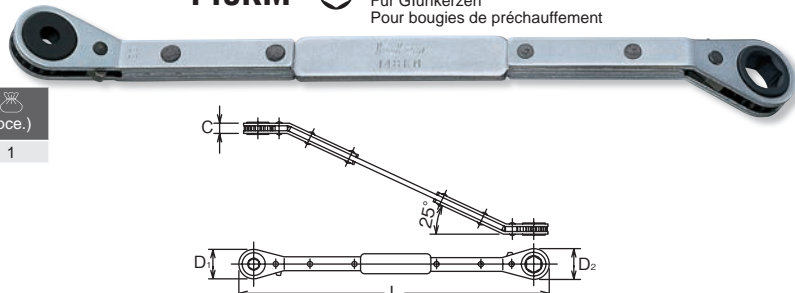

148KM (mm)	L (mm)	D ₁ (mm)	D ₂ (mm)	C (mm)	 (g)	 (pce.)
8Sx12	245	23.6	24.6	9	187	1

Z-SERIES
 HAND
 TITANIUM
 SCREWDRIVERS ACCESSORIES
 IMPACT
 SLEEVE-DRIVE
 PROTECTOR
 INDUSTRIAL
 AUTOMOTIVE
 MOTORCYCLE
 CONSTRUCTION
 SPARE PART

SP4305M-77  Socket for Diesel engine injectors
 Steckschlüssel für Diesel-Einspritzdüsen
 Douilles spéciales pour injecteurs

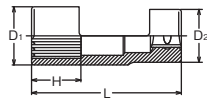
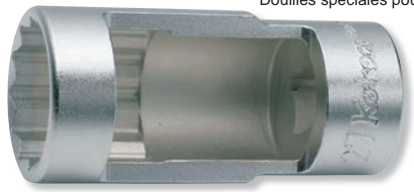

SP4305M-77 (mm)		D ₁ (mm)	D ₂ (mm)	H (mm)	L (mm)	(g)	(pcs.)
27	1/2"	36.5	33	28	77	212	10

SP4305M.77-27
 For fuel injection pump of BMW diesel cars.

4133 Socket for Diesel engine injectors
 Steckschlüssel für Diesel-Einspritzdüsen
 Douilles spéciales pour injecteurs

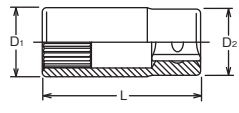

		D ₁ (mm)	D ₂ (mm)	L (mm)	(g)	(pcs.)
4133	1/2"	23.9	23	55	86	10

4133
 For fuel injection pump of M.B diesel cars.

4122-72 Diesel Injection Holder Nut Socket
 Steckschlüssel für Einspritzdüsen
 Douilles pour injecteur diesel

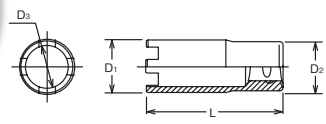

4122-72 (mm)		D ₁ (mm)	D ₂ (mm)	D ₃ (mm)	L (mm)	(g)	(pcs.)
22	1/2"	28.5	27	22	72	150	10

4122.72-22
 For M.B Trucks, Holder nut of injection post.

SP4122-69 Diesel Injection Holder Nut Socket
 Steckschlüssel für Einspritzdüsen
 Douilles pour injecteur diesel

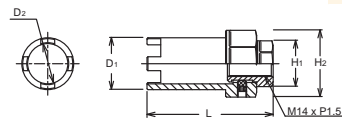

SP4122-69 (mm)	D ₁ (mm)	D ₂ (mm)	H ₁ (mm)	H ₂ (mm)	L (mm)	(g)	(pcs.)
22	28.4	22	22	32	69	185	5

3300FN  Flare Nut Sockets
 Geschlitzte Steckschlüssel für Überwurfmuttern
 Douilles à tuyauter

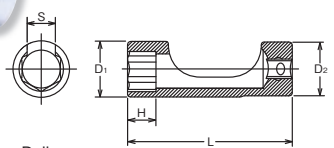

3300FN (mm)		D ₁ (mm)	D ₂ (mm)	H (mm)	L (mm)	S (mm)	(g)	(pcs.)
8		14.5	17.3	6	53	6.4	38	10
9		16	17.3	7	53	6.8	41	10
10		16.8	17.2	7.5	53	7.2	42	10
11		18	17	8.5	53	8.3	42	10
12		20	18	9	53	8.8	50	10
13		21.1	20	9.5	62	9.4	66	10
14		22	20	10.5	62	10.5	66	10
15	3/8"	23	22	11	70	11.5	82	10
16		24	23	11.5	70	12	90	10
17		25	24	12.5	80	13	110	10
18		27	25	13	80	13.5	120	10
19		28	26	14	80	14.5	130	10
22		32	29.5	16	80	16	180	10
24		34.5	31.5	17	80	17	200	10

RS3300FN/8	8 Pieces Set/Rail 200mm	(g)
9, 10, 11, 13, 14, 16, 17, 19		600

RS3300FN/8   Socket Set on Rail
 Steckschlüsselsatz auf Schiene
 Jeu de douilles sur rail

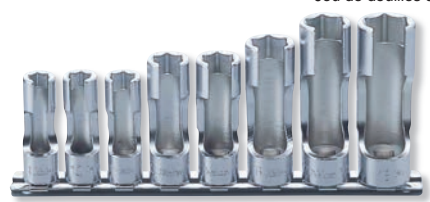

SP4300M-85  Special socket for Lambda Probes
 Spezialsteckschlüssel für Lambda Sonden
SP4300M-110  Douilles spéciales pour sonde Lambda

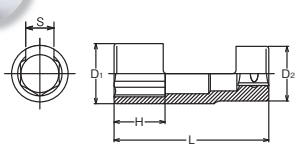

		D ₁ (mm)	D ₂ (mm)	H (mm)	L (mm)	S (mm)	(g)	(pcs.)
SP4300M.85-22	1/2"	33	30	29	85	8	228	10
SP4300M.110-22		33	30	34	110	8	279	5

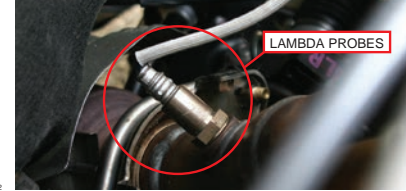

Socket for Lambda Probes
 Open section allows for use with wire/connector.

4300H (mm)		D ₁ (mm)	D ₂ (mm)	H ₁ (mm)	H ₂ (mm)	H ₃ (mm)	L (mm)	(g)	(pcs.)
24	1/2"	32.5	27	17	40	24	57	157	10
26		35	27	19	40	24	57	170	10
27		36.1	27	19.5	40	24	57	175	10

4300H series
Removes and installs oil pressure switches

4300H (mm)		D ₁ (mm)	D ₂ (mm)	H ₁ (mm)	H ₂ (mm)	L (mm)	(g)	(pcs.)
27(8P)	1/2"	34	27	18.5	37	57	152	10

4300H(8P) series
Socket for Switches, Mercedes Benz and MAN

4010M-100 (mm)		D (mm)	H (mm)	L (mm)	(g)	(pcs.)
8(12P)	1/2"	23	63.5	100	132	10
10(12P)		23	63.5	100	135	10

4010M-120 (mm)		D (mm)	H (mm)	L (mm)	(g)	(pcs.)
8(12P)	1/2"	23	83.5	120	151	10
10(12P)		23	83.5	120	155	10



Cylinder head bolt socket for TOYOTA
4010M(12P) is Double Hex bit socket.
XZN(Triple Square) bit socket has different shape.

ST4027.140 (mm)		D (mm)	H (mm)	L (mm)	(g)	(pcs.)
ST4027.140	1/2"	23	103.5	140	155	10



Head Bolt Bit Socket for VW/AUDI
ST4027-140 can not substitute with 3027, 4027-CV bit series.

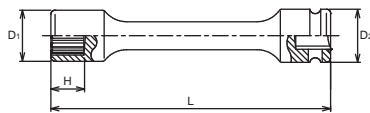

13145M-150 (12P) (mm)		D ₁ (mm)	D ₂ (mm)	H (mm)	L (mm)	(g)	(pcs.)	
10	3/8"	15.8	19	10	150	120	1	*1
12		18.3	19	12	150	128	1	*1

*1 C-Ring=C31, Pin/O-Ring=A31/B31 → P256-257

4300H Oil Pressure Switch Sockets
Steckschlüssel für Öldruckschalter
Douilles pour interrupteur, pression d'huile

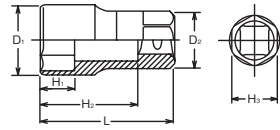

4300H (8P) 8-point Sockets
8-kant Steckschlüssel
Douilles 8-pans

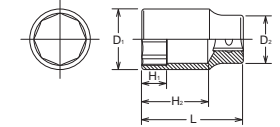

4010M-100 / -120 (12P) Bit Sockets for Double Inhex Screws (12-point)
Steckschlüssel für Innenzwölfkant-Schrauben
Douilles à 6-pans doubles

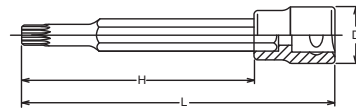

ST4027-140 Head Bolt Bit Socket for VW/AUDI
Bit Steckschlüssel für Zylinderkopfschrauben VW/AUDI
Douilles tournevis spéciales pour boulons de classe VW/AUDI

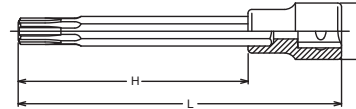

13145M-150 / -200 (12P) Extra Long Sockets
Schaftsteckschlüssel
Douilles, série allongée



13145M.200 (12P) (mm)		D ₁ (mm)	D ₂ (mm)	H (mm)	L (mm)	(g)	(pcs.)	
10	3/8"	15.8	19	10	200	151	1	*1
12		18.3	19	12	200	159	1	*1

*1 C-Ring=C31, Pin/O-Ring=A31/B31 → P256-257

16305M (mm)		D ₁ (mm)	D ₂ (mm)	H ₁ (mm)	H ₂ (mm)	L (mm)	(g)	(pcs.)	
14	3/4"	26.3	44	14	74	100	500	2	*1
17		30	44	17	74	100	544	2	*1
19		32.5	44	19	74	100	655	2	*1
22		36.3	44	22	74	100	700	2	*1

*1 C-Ring=C61, Pin/O-Ring=A61/B61 → P256-257

16305M 12-point Sockets, deep
12-kant Steckschlüssel, lang
Douilles longues, 12-pans

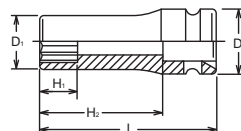

Z-SERIES
 HAND
 TITANIUM
 SCREWDRIVERS ACCESSORIES
 IMPACT
 SLEEVE-DRIVE
 PROTECTOR
 INDUSTRIAL
 AUTOMOTIVE
 MOTORCYCLE
 CONSTRUCTION
 SPARE PART

4109M  Double 4-point Sockets
 Doppelvierkant Steckschlüssel
 Douilles 4-pans, doubles

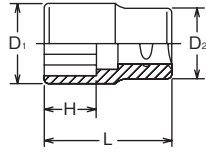

4109M (mm)		D ₁ (mm)	D ₂ (mm)	H (mm)	L (mm)	(g)	(pcs.)
14	1/2"	26.8	26	11	38	110	10
17		30	28	12.5	40	140	10
19		31.5	29	14	40	150	10
21.5		35	32	16	40	170	10
23		37	34	16.5	43	180	10

4109M series
 For Lubrication service

4111M  6-point Sockets
 6-kant Steckschlüssel
 Douilles 6-pans

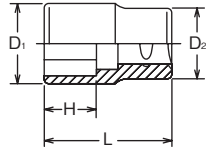

4111M (mm)		D ₁ (mm)	D ₂ (mm)	H (mm)	L (mm)	(g)	(pcs.)
24	1/2"	32	30	17	40	133	10

4111M
 For Lubrication service

4020-60 (MH)  Bit Socket for Triple Square with hole
 Steckschlüssel für XZN-Schrauben mit Loch
 Douilles tournevis avec trou pour empreinte XZN

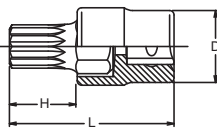



4020-60 (XZN)		D (mm)	H (mm)	L (mm)	(g)	(pcs.)
MH16	1/2"	24	20	60	135	10

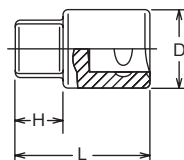

4020-60-MH16
 Specially designed for oil drain plug on gearbox of AUDI, VW, PORSCHE.

3110M / 3110A  4-point Male Sockets
 Öldienst-Steckschlüssel
 Douilles mâles 4-pans





3110M (mm)		D (mm)	H (mm)	L (mm)	(g)	(pcs.)
6	3/8"	18	10	28	30	10
8		18	10	28	30	10
10		18	10	28	33	10
12		18	10	28	37	10

3110A (inch)		D (mm)	H (mm)	L (mm)	(g)	(pcs.)
5/16	3/8"	18	10	28	30	10
3/8		18	10	28	33	10
1/2		18	10	28	37	10

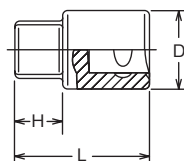
4110M / 4110A  4-point Male Sockets
 Öldienst-Steckschlüssel, Vierkant
 Douilles mâles 4-pans



4110M (mm)		D (mm)	H (mm)	L (mm)	(g)	(pcs.)
8	1/2"	24	10	32	57	10
10		24	10	32	62	10
10.5		24	10	32	64	10
12		24	10	32	64	10
13		24	10	32	66	10
13.5		24	10	32	67	10
19		25	15	37	101	10
20		26	15	37	114	10

4110A (inch)		D (mm)	H (mm)	L (mm)	(g)	(pcs.)
3/8	1/2"	24	10	32	62	10
1/2		24	10	32	64	10

158  For Lubrication Service
Schmierdienst-Werkzeuge
Service lubrification-vidange



158 (mm)	L ₁ (mm)	L ₂ (mm)	d (mm)	(g)	(pcs.)
8Sx10S	63	230	13	319	1

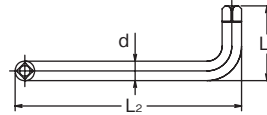

3012M-25 (mm)		D (mm)	L (mm)	(g)	(pcs.)
14	3/8"	19	25	30	10
17		19	25	30	10

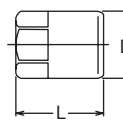

3012M-25  Inhex Sockets
Steckschlüssel für Innensechskant-Schrauben
Douilles tournevis pour vis 6-pans creux



4202 7 Pieces Set/ =426g

METAL CASE:W190xH59xT45mm



Sockets

-  **106 Drain Plug Keys**
8Sx10S, 8Hx3/8H, 10Hx11H, 12Hx13H, 14Hx17H, 19H
-  **4102 Drain Plug Key Adaptor**

4202 Drain Plug Keys Set
Öldienst-Satz
Jeu d'embouts pour le montage et démontage des bouchons de vidange



106 (mm)	H ₁ (mm)	H ₂ (mm)	H ₃ (mm)	L (mm)	(g)	(pcs.)
8Sx10S	8	8	17	32	40	10
8Hx3/8H	8	8	17	32	38	10
10Hx11H	8	8	17	32	42	10
12Hx13H	8	8	17	32	47	10
14Hx17H	8	8	17	32	55	10
19H	-	8	17	24	49	10

106   4-point / 6-point Male bits
Innenvierkant / Innensechskantsteckschlüssel
Embouts mâles 4-pans / 6-pans

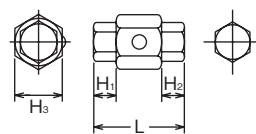

4102 (mm)		D ₁ (mm)	D ₂ (mm)	H (mm)	L (mm)	(g)	(pcs.)
17	1/2"	25	24	16	40	82	10

4102  Adaptor for 106 Drain plug key
Halter für Öldienst-Einsätze 106
Porte embouts pour 106

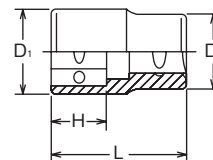
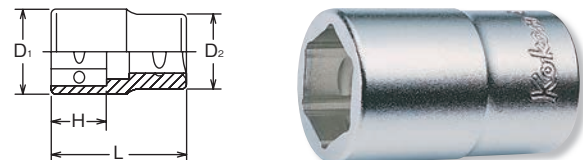

3400M-24 (mm)		D ₁ (mm)	D ₂ (mm)	H (mm)	L (mm)	(g)	(pcs.)
27	3/8"	36.5	21.5	13.5	24	76	10
30		40	25	13.5	24	91	10
32		42.8	28	13.5	24	108	10
36		47.2	32	13.5	24	135	10

3400M-24  Extra short 6-point Sockets for Oil-Filter Service
Extra kurze Steckschlüssel für Ölfilter
Douille extra courte pour filtre à huile

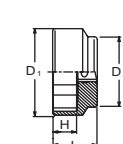

Z-SERIES
 HAND
 TITANIUM
 SCREWDRIVERS ACCESSORIES
 IMPACT
 SLEEVE-DRIVE
 PROTECTOR
 INDUSTRIAL
 AUTOMOTIVE
 MOTORCYCLE
 CONSTRUCTION
 SPARE PART

1206  Push and Pull-Ratchet
 Hub Knarre
 Clé à cliquet de levage



1206		3 Pieces Set/△=320g	
CARDBOARD BOX			
Sockets		Accessory	
	150.14H Sockets 12, 14	154K-14	

154K  Push and Pull-Ratchets
 Hub Knarre
 Clé à cliquet de levage

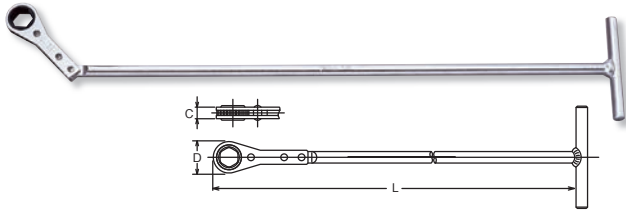

154K (mm)	L (mm)	D (mm)	C (mm)	 (g)	 (pcs.)
14	480	24.6	9	280	1



150-14H  Socket, For 154K
 Einsätze für 154K
 Douilles pour 154K

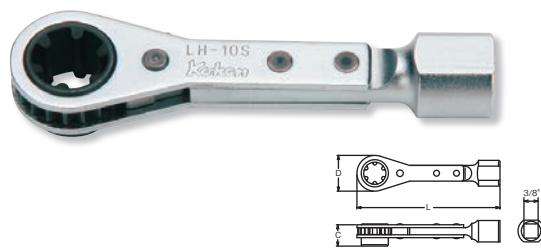

150-14H (mm)	D (mm)	H (mm)	L (mm)	 (g)	 (pcs.)
10	16	5	17	16	10
12	17.3	5	18	14	10
14	19.2	7	21	17	10

145LH3/8F  Belt Tension Pulley Wrench
 Knarren-Ringschlüssel für Riemen-Spannrolle
 Clé multicrân à cliquet pour galet-tendeur 



145LH3/8F (LH-S)		L (mm)	D (mm)	C (mm)	 (g)	 (pcs.)
10S	3/8"	100	25	15.5	90	10

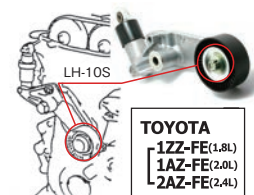

Belt Tension Pulley Wrench
 For LH-10S bolt on TOYOTA engines 1ZZ (1.8L), 1AZ (2.0L) and 2AZ (2.4L), belt tension pulley.

TOYOTA
1ZZ-FE(1.8L)
1AZ-FE(2.0L)
2AZ-FE(2.4L)

 This item has less strength due to the special design.

4282 1/2" Sq.Dr. Generator Service Set
 1/2" Lichtmaschinen-Service Satz
 Jeu 1/2" pour l'entretien des générateurs électriques



4282		4 Pieces Set/△=449g	
PLASTIC BAG			
Sockets			
	1/2"	4020.100-M10 4020.140-M10	
	1/2"	4025.100R-T50	
		185	



Generator Service Set
 For removing and installing belt pulley at the generator.

17mm Hex. drive

1210E Door Hinge Wrench Set
Montagesatz für Kfz-Türscharniere
Jeux d'outils spéciaux pour charnières de portes



1210E		11 Pieces Set/△=460g
PLASTIC BAG		
Sockets	Accessory	
<ul style="list-style-type: none"> 179B.12H Sockets 10, 12, 13 179B.12H XZN Bits M8, M10, M12 179B.12H TORX® Bits T40, T45, T50 179B.12H Hex Bit 8 	145KD-12	

3247 4 Pieces Set/△=385g
PLASTIC BAG

Sockets
3/8" 3025.160 Tamper-resistant TORX® Bit Sockets T27H, T30H, T40H, T50H

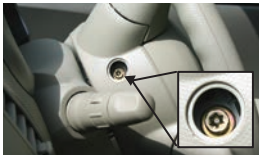

For Air Bag
For air-bag unit in hard to reach places in or around the steering wheel.

Tamper Resistant TORX® Bit Sockets have less strength.

3300M/4-L120 4 Pieces Set/△=477g
PLASTIC BAG

Sockets
3/8" 3300M(L120) 6-pt. Extra Deep Sockets 8, 10, 12, 14



Extra Deep Socket
Extra deep socket can be used to fasten or loosen longer bolts such as Bumper bolt and Door hinge etc.

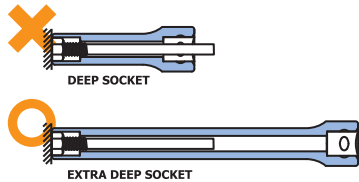

3350M/2-L120 2 Pieces Set/△=230g
PLASTIC BAG

Sockets
3/8" 3350M(L120) Nut Grip Extra Deep Sockets 10, 12

Nut Grip Extra Deep Socket

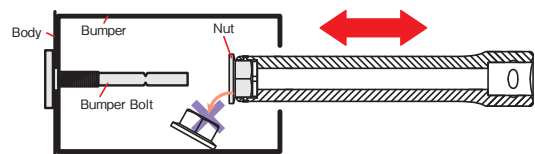

3247 Bit Socket Set
Schraubendreher-Steckschlüssel Satz
Jeu de douilles de vissage



3300M/4-L120 Socket Set
Steckschlüssel Satz
Jeu de clés à douille



3350M/2-L120 Socket Set
Steckschlüssel Satz
Jeu de clés à douille



Z-SERIES
 HAND
 TITANIUM
 ACCESSORIES
 SCREWDRIVERS
 IMPACT
 SLEEVE-DRIVE
 PROTECTOR
 INDUSTRIAL
 AUTOMOTIVE
 MOTORCYCLE
 CONSTRUCTION
 SPARE PART

1212 Long shank Screwdriver 4 pieces set
 Extra lange Schraubendreher 4teiliger Satz
 Tournevis longs. Jeu de 4 pièces



168T (250) Extra long shank Screwdrivers
 Extra lange Schraubendreher
 Tournevis extra longs

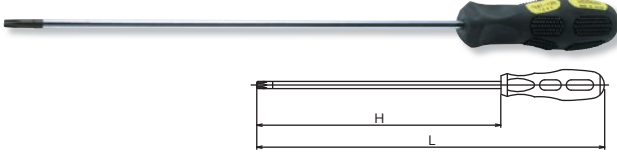

169/2 Door Trim Pad Tool, 2 pieces set
 Demontagehebel für Türclips, Satz 2-teilig
 Jeu, levier pour le démontage des garnitures de portes



169WM Window Molding Remover
 Zum Lösen von Fenstergummis
 Pour le démontage des joints de vitres



169HR/2 Hose Remover, 2 pieces set
 Universalhaken, 2teiliger Satz
 Pour le démontage des tuyaux. Jeu de 2 pièces

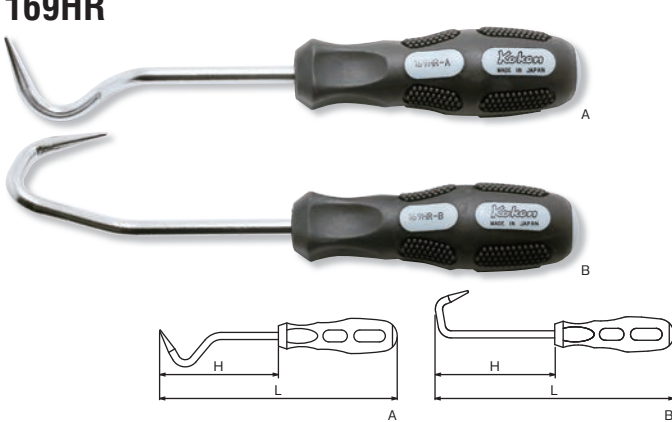

169BP For Battery Screws
 Für Batterie-Verschlussstopfen
 Pour vis de batterie



1212 4 Pieces Set/⚖️=380g
 PLASTIC BAG

Screwdrivers	
168T(250) 20IPR	
168T(250) T20, T25, T30	

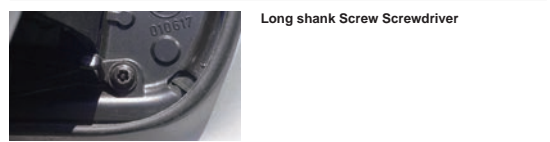

168T(250) (IPR)	H (mm)	L (mm)	⚖️ (g)	📦 (pce.)
20IPR	250	350	85	1

168T(250) (T)	H (mm)	L (mm)	⚖️ (g)	📦 (pce.)
T20	250	350	85	1
T25	250	350	85	1
T30	250	360	120	1

169/2 2 Pieces Set/⚖️=200g
 PLASTIC BAG

Clip Handles	
169	6, 10

169	H ₁ (mm)	H ₂ (mm)	L (mm)	⚖️ (g)	📦 (pcs.)
6	115	5	215	80	2
10	120	9	230	110	2



169WM	H (mm)	L (mm)	⚖️ (g)	📦 (pcs.)
169WM	100	210	90	2

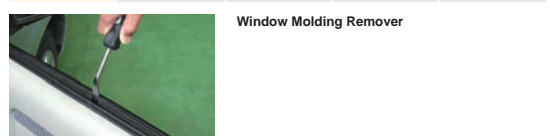

169HR/2 2 Pieces Set/⚖️=180g
 PLASTIC BAG

Hose Remover	
169HR A, B	

169HR	H (mm)	L (mm)	⚖️ (g)	📦 (pcs.)
A	100	200	75	2
B	100	200	90	2

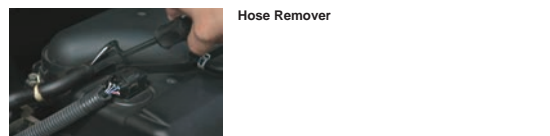

169BP	TxW (mm)	H (mm)	L (mm)	⚖️ (g)	📦 (pcs.)
1.8x13	1.8x13	50	150	60	2

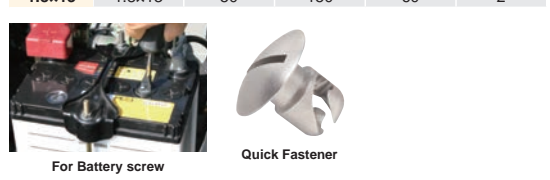

Z-SERIES
HAND
TITANIUM
ACCESSORIES
SCREWDRIVERS
IMPACT
SLEEVE-DRIVE
PROTECTOR
INDUSTRIAL
AUTOMOTIVE
MOTORCYCLE
CONSTRUCTION
SPARE PART

4425 (E)		D ₁ (mm)	D ₂ (mm)	H (mm)	L (mm)	(g)	(pcs.)
E10N		13.2	21	8.2	36	47	10
E12N		14.6	21	9.3	37	48	10
E14N		16.5	21	10.6	37	50	10
E16N		19	22	11.8	37	60	10
E18N		20.3	22	13	37	60	10
E20N		22.8	22	14.4	37	65	10

4425-N TORX® Sockets
TORX® Steckschlüssel
Douilles TORX®

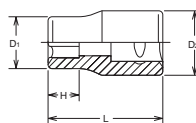

RS4425/6-N	6 Pieces Set/Rail 200mm	(g)
E10N, E12N, E14N, E16N, E18N, E20N		370



Engine type : QR/MR
Flywheel bolt for NISSAN E20N

RS4425/6-N Socket Set on Rail
Steckschlüsselsatz auf Schiene
Jeu de douilles sur rail



13145A.150 (inch)		D ₁ (mm)	D ₂ (mm)	H (mm)	L (mm)	(g)	(pcs.)	
9/16(D20)		20	19	13	150	130	5	*1

*1 C-Ring=C31, Pin/O-Ring=A31/B31 → P256-257

13145A-150 Extra Long Socket
Schaftsteckschlüssel
Douilles, série allongée

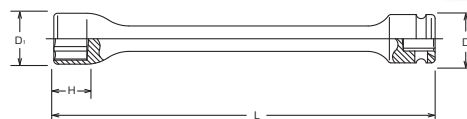

14145A.150 (inch)		D ₁ (mm)	D ₂ (mm)	H (mm)	L (mm)	(g)	(pcs.)	
9/16(D20)		20	25	13	150	200	5	*1

*1 C-Ring=C41, Pin/O-Ring=A41/B41 → P256-257

For Land Rover Prop Shaft

13772 Universal Double Joint
14772 Doppelgelenk-Einsatz
Joint articulé double

		D ₁ (mm)	D ₂ (mm)	L (mm)	(g)	(pcs.)	
13772-B		22	19	75	120	5	*1
13772-P		22	19	75	120	5	*1
14772-B		27	25	90	230	1	*2
14772-P		27	25	90	230	1	*2

*1 C-Ring=C31, Pin/O-Ring=A31/B31 → P256-257
*2 C-Ring=C41, Pin/O-Ring=A41/B41

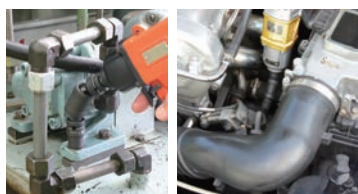

13772 and 14772 have less load capacity than standard. In the interest of your safety always use properly.

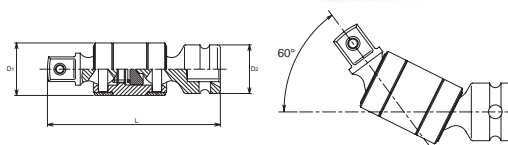

14305M (mm)		D ₁ (mm)	D ₂ (mm)	H ₁ (mm)	H ₂ (mm)	L (mm)	(g)	(pcs.)	
30		42	30	30	63	85	457	10	*2
32		44.5	30	32	63	85	542	10	*2
36		49.5	30	36	61	85	635	2	*2

*2 C-Ring=C42, Pin/O-Ring=A42/B42 → P256-257



14305M 12-point Deep Sockets
12-kant Steckschlüssel, lang
Douilles longues 12-pans

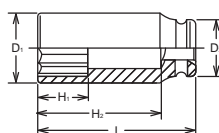

4101		TxW (mm)	D (mm)	L (mm)	(g)	(pcs.)
1		2.7x18.6	22	40	59	10
2		3.7x24	24	40	79	10
3		3.7x30	30	40	128	10

4101 Sockets for Slotted Heads
6101 Steckschlüssel für Schlitzschrauben
Douilles tournevis pour vis à fente

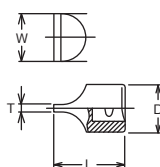

6101		TxW (mm)	D (mm)	L (mm)	(g)	(pcs.)
6101		6.4x33.5	35	50	205	5

TORX is a registered trademark of CAMCAR Innovations.
TORX ist ein registriertes Markenzeichen der Firma CAMCAR Innovations.
TORX est une marque déposée de CAMCAR Innovations.

Z-SERIES
 HAND
 TITANIUM
 SCREWDRIVERS ACCESSORIES
 IMPACT
 SLEEVE-DRIVE
 PROTECTOR
 INDUSTRIAL
 AUTOMOTIVE
 MOTORCYCLE
 CONSTRUCTION
 SPARE PART

4300M (L60)



Wheel Nut Sockets
 Radmuttern Steckschlüssel
 Douilles pour écrous de roue

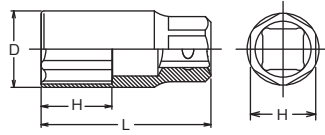

4300M(L60) (mm)		D (mm)	H (mm)	L (mm)	H (mm)	 (g)	 (pcs.)
17	1/2"	23.8	25	60	21	98	10
19		25.8	25	60	21	100	10
21		27.6	25	60	21	102	10



Wheel Nut Sockets

Please note that thin walled design is only for wheel nut work and Torque rating is limited.

4300M (L110)



Wheel Nut Sockets (Long)
 Radmuttern-Steckschlüssel, extra lang
 Douilles extra longues pour écrous de roue

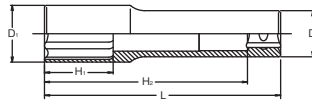

4300M(L110) (mm)		D ₁ (mm)	D ₂ (mm)	H ₁ (mm)	H ₂ (mm)	L (mm)	 (g)	 (pcs.)
17	1/2"	23.8	22	32	93	110	155	5
19		25.8	22	32	93	110	170	5
21		27.6	22	32	93	110	165	5

Please note that thin walled design is only for wheel nut work and Torque rating is limited.

4711X



Spinning cross wrench
 T-Griff für die Radmuttermontage
 Poignée coulissante pour montage des écrous à roue

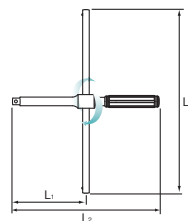

		L ₁ (mm)	L ₂ (mm)	L ₃ (mm)	 (g)	 (pce.)
4711X	1/2"	140	280	350	945	1

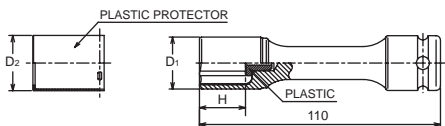

14201M 14145PM-110

- Wheel Nut Sockets Set
- Radmuttern Steckschlüssel im Satz
- Douilles pour écrous de roue
- Wheel Nut Sockets
- Radmuttern Steckschlüssel
- Douilles pour écrous de roue



14201M 3 Pieces Set/690g
CARDBOARD BOX:W125xH95xT34mm

Sockets							
14145PM.110 Impact Wheel Nut Sockets 17, 19, 21							
14145PM-110 (mm)		D ₁ (mm)	D ₂ (mm)	H (mm)	Shaft Colour	(g)	(pcs.)
17		23.8	25.2	21	Blue	208	5 *1
19	1/2"	25.8	27.2	23	Red	219	5 *1
21		27.6	29	25	Yellow	226	5 *1
22		29	30.5	26	White	238	5 *1

*1 C-Ring=C41, Pin/O-Ring=A41/B41 → P256-257



PLASTIC PROTECTOR KUNSTSTOFF HÜLSE PROTECTION EN PLASTIQUE

A detachable plastic protector is fitted to the socket to prevent damage to the wheel when working in tight areas. The socket size and Ko-ken mark printed on the shaft makes it easier to see if the socket is still rotating or stopped.

Zum Schutz empfindlicher Leichtmetallfelgen ist eine drehbare und abnehmbare Kunststoff Hülse an dem Steckschlüssel montiert. Die aufgedruckten Markierungen am Werkzeugschaft zeigen außerdem ob das Werkzeug steht oder rotiert.

La douille est pourvue d'un insert en plastique détachable. Il sert à prévenir tout dommage aux jantes lors de l'utilisation des douilles.

Le marquage sur la tige rend l'identification des douilles très facile.

198-17 : Spare Plastic Protector for 14145PM.110-17 : 10 pcs.
198-19 : Spare Plastic Protector for 14145PM.110-19 : 10 pcs. 280PM-19
198-21 : Spare Plastic Protector for 14145PM.110-21 : 10 pcs. 280PM-21
198-22 : Spare Plastic Protector for 14145PM.110-22 : 10 pcs.

14145M-110 (mm)		D ₁ (mm)	D ₂ (mm)	H (mm)	(g)	(pcs.)
New 17MB	1/2"	25.7	27.2	11.5	256	5



Mercedes Benz Wheel Bolt

280PM (mm)	D ₁ (mm)	D ₂ (mm)	H ₁ (mm)	L (mm)	H ₂ (mm)	Shaft Colour	(g)	(pcs.)
19	25.8	27.2	13	52	19	Red	150	5
21	27.6	29	13	55	21	Yellow	180	5



Designed for Low Profile Wheel nut socket.

Detachable plastic protector is fitted to the adaptor to prevent damage to painted or surface treatment area on the wheel. The Plastic insert locate inside of the adaptor prevents damage to wheel nut. Colour coded band make size identification easy.

Die abnehmbare Kunststoffhülse schützt die Felge vor Kratzern oder Schrammen an der empfindlichen Oberfläche. Der Kunststoffanschlag im inneren des Werkzeugs schützt zusätzlich die Radmutter. Die Farbmarkierung macht die Identifikation des Werkzeugs einfach.

La protection plastifiée amovible, protège la jante et évite des endommagements sur des surfaces délicates. Le plastic inséré à l'intérieur de l'outil protège également l'écrou de roue. L'identification de l'outil est simplifiée par le marquage en couleur.

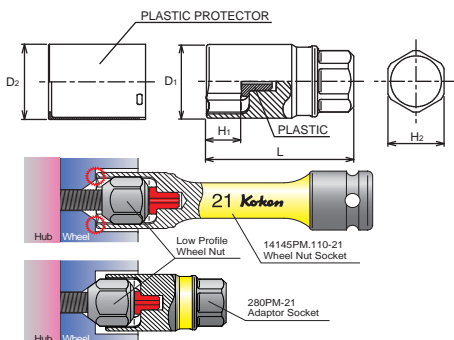

14145M-110MB Wheel Bolt Socket

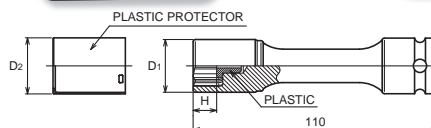

280PM Adaptor Socket for Low Profile Wheel Nut



- Adaptor Steckschlüssel für kurze Radmutter
- Adapteur pour des écrous de roue courts



Z-SERIES
 HAND
 TITANIUM
 SCREWDRIVERS ACCESSORIES
 IMPACT
 SLEEVE-DRIVE
 PROTECTOR
 INDUSTRIAL
 AUTOMOTIVE
 MOTORCYCLE
 CONSTRUCTION
 SPARE PART

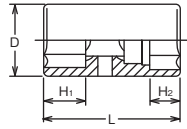
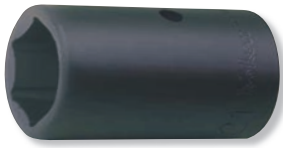



14118M  Wheel Nut Sockets, Double Ended
 Radmuttern Steckschlüssel, doppelseitig
 Douilles pour écrous de roue à ouvertures doubles



14118M (mm)		D (mm)	H ₁ (mm)	H ₂ (mm)	L (mm)	(g)	(pcs.)
17x19		28	15.5	13	48	150	10
19x21		31	17.5	13	57	177	10
19x22		31	17.5	15	57	187	10

14218M  Wheel Nut Sockets, Double Ended with Extension Bar
 Radmuttern Steckschlüssel, doppelseitig, mit Verlängerung
 Douille pour écrous de roue à ouvertures double plus rallonge





14218M		2 Pieces Set/  =360g	
CARDBOARD BOX			
Sockets		Accessory	
		14118PM 19x21	 14760ST-B

Interchangeable Wheel Nut Socket of 19mm and 21mm.

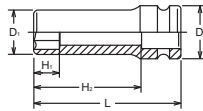
AN14300  Impact Sockets, Aluminium alloyed, for aluminium wheel nuts
 Aluminium-legierte Impact Steckschlüssel für Aluminium Radmuttern
 Douilles Impact en aluminium pour écrous de roue aluminium





AN14300 (mm)		D ₁ (mm)	D ₂ (mm)	H ₁ (mm)	H ₂ (mm)	L (mm)	(g)	(pcs.)	
17		25.7	30	17	62	80	85	10	*1
19		28.2	30	19	61	80	89	10	*1
21		30.7	30	21	61	80	93	10	*1

*1 C-Ring=C42, Pin/O-Ring=A42/B42  P256-257

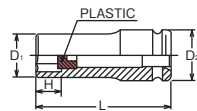
14113J  Impact Sockets with Plastic Stops for Hub Cap Screws
 Impact Steckschlüssel mit Plastik-Anschlag für Zier-Radmuttern
 Douilles Impact avec arrêt en plastique, pour écrous de roue décoratifs





14113J (mm)		D ₁ (mm)	D ₂ (mm)	H (mm)	L (mm)	(g)	(pcs.)	
17		25.7	30	14	80	251	10	*1
19		28.2	30	16	80	286	10	*1
21		30.7	30	20	80	309	10	*1

*1 C-Ring=C42, Pin/O-Ring=A42/B42  P256-257

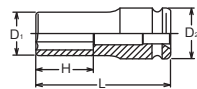
14113M  For Hub Cap Screws
 Für Zier-Radmuttern
 Pour écrous de roue décoratifs



14113M (mm)		D ₁ (mm)	D ₂ (mm)	H (mm)	L (mm)	(g)	(pcs.)	
17		25.7	30	34	80	230	10	*1
19		28.2	30	38	80	262	10	*1
21		30.7	30	42	80	285	10	*1

*1 C-Ring=C42, Pin/O-Ring=A42/B42  P256-257

14124 (mm)		D ₁ (mm)	D ₂ (mm)	H ₁ (mm)	H ₂ (mm)	L (mm)		
21x24.5	1/2"	28	29.5	24	25	65	157	10
26x27.5		31.5	35	24.5	24.5	65	197	10

14124 Lock Nut Busters (Double Ended)
Felgenschloss-Knacker, doppelseitig
Douilles taraudées à ouvertures doubles pour
dévisser les écrous ou goujons de roue antivols.

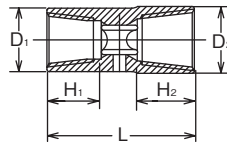

14124/3		3 Pieces Set/=580g
CARDBOARD BOX:W125xH91xT43mm		
Sockets	Accessory	
14124 21x24.5 26x27.5		14760-75B



14124/3 Lock Nut Busters (Double Ended) in Set
Felgenschloss-Knacker, doppelseitig im Satz
Jeu de douilles taraudées à ouvertures doubles pour
dévisser les écrous ou goujons de roue antivols.



14124 (mm)		D ₁ (mm)	D ₂ (mm)	H (mm)	L (mm)			
17	1/2"	20.5	25	15	50	83	10	*1
18		21	25	15	50	83	10	*1
18.5		23	25	15	50	95	10	*1
19		25	30	20.5	50	140	10	*2
21		28	30	20.5	50	153	10	*2
24.5		29.5	30	23	50	138	10	*2
26		31.5	30	23	50	147	10	*2
27.5	35	30	23	50	181	10	*2	

*1 C-Ring=C41, Pin/O-Ring=A41/B41 → P256-257
*2 C-Ring=C42, Pin/O-Ring=A42/B42

14124 Lock Nut Busters
Felgenschloss-Knacker
Douilles taraudées pour dévisser les
écrous ou goujons de roue antivols.

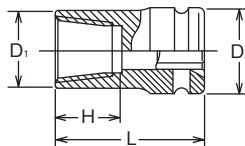

RS14124/7	7 Pieces Set/Rail 250mm	
18, 18.5, 19, 21, 24.5, 26, 27.5		980

RS14124/7 Socket Set on Rail
Steckschlüsselsatz auf Schiene
Jeu de douilles sur rail



Z-SERIES
 HAND
 TITANIUM
 SCREWDRIVERS ACCESSORIES
 IMPACT
 SLEEVE-DRIVE
 PROTECTOR
 INDUSTRIAL
 AUTOMOTIVE
 MOTORCYCLE
 CONSTRUCTION
 SPARE PART

14101MP Torsion Bars (for tightening only)
 Torsionsstäbe (nur zum Anziehen)
 Barres de torsion (pour serrage seulement)

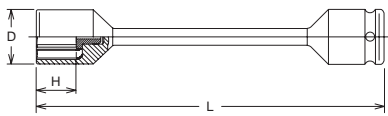
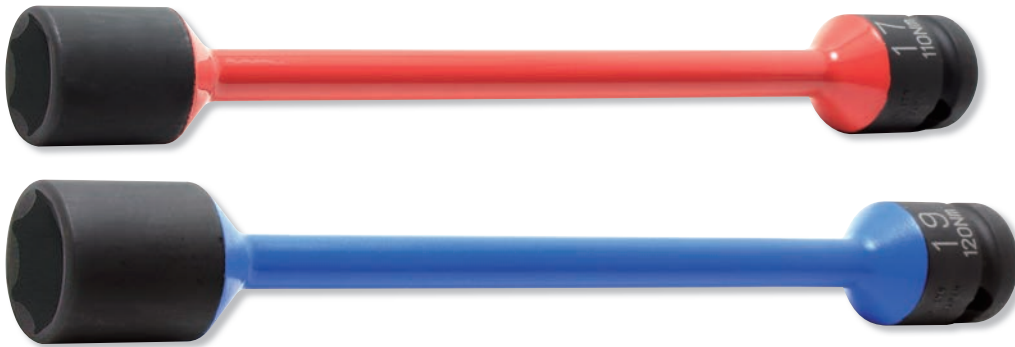

As the torque could vary with the type and the condition of the impact wrench, we strongly recommend the control with a torque wrench.

Da die Drehmomentwerte von Art und Leistung des verwendeten Schlagschraubers abhängen, empfehlen wir die Kontrolle der Kombination Schlagschrauber/Torsionsstab mittels eines Drehmomentschlüssels.

Etant donné que le couple peut varier selon modèle, la capacité ou l'état de la clé à choc, le contrôle de la combinaison clé à choc/barre par clé dynamométrique est indispensable.

14101MP (mmxNm)		D (mm)	H (mm)	L (mm)	Shaft Colour		
17x 95Nm		24	16	214		10	*1
17x110Nm		24	16	204		10	*1
17x120Nm		24	16	203		10	*1
19x 90Nm		26	18	259		10	*1
19x100Nm		26	18	233		10	*1
19x120Nm		26	18	204		10	*1
19x140Nm		26	18	199		10	*1
21x100Nm		28	22	216		10	*1
21x120Nm		28	22	205		10	*1
22x150Nm		29	22	220		10	*1

*1 C-Ring=C41, Pin/O-Ring=A41/B41 → P256-257

14101MP-M/8 Metal-Wall-Hanger for Workshops
 Werkstatt-Wandhänger (Metall)
 Support métallique d'atelier



14101MP-M/8 8 Pieces Set/△=2,300g
 HANGER

Torsion Bar
14101MP Impact Torsion Bars
 17x95Nm, 17x110Nm, 17x120Nm,
 19x90Nm, 19x100Nm, 19x120Nm, 19x140Nm, 21x100Nm

Torque table included in delivery.

Drehmomenttabelle wird mitgeliefert.

Tableau des couples de serrage inclus dans la livraison.

Torsion Bars

- Designed for tightening wheel nuts with an impact wrench.
- Prevent the excessive torque road.
- Colour coded shafts make size identification easy.



Torsionsstäbe

- Zur Montage von Radmuttern mit dem Schlagschrauber.
- Schützt die Radmutter vor zu hohen Anzugsmomenten.
- Die Farbmarkierung erleichtert das Erkennen des passenden Werkzeugs.



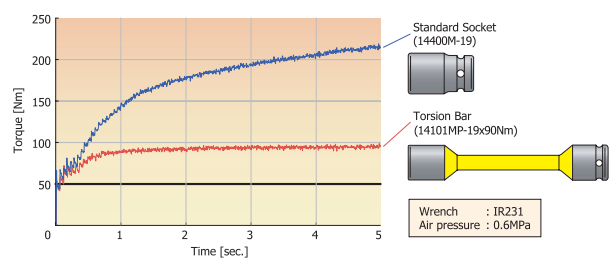

Barres de torsion

- Pour le montage d'écrou de roue avec visseuse à chocs.
- Protège l'écrou d'un serrage à couple excessif.
- La colorisation des barres facilite l'identification des tailles.

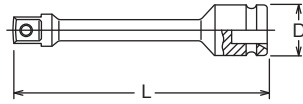



14112-P  Torsion Extension Bars (for tightening only)
Torsionsstab-Verlängerungen (nur zum Anziehen) 
Barres de torsion (pour serrage seulement)







14112-P (Nm)		D (mm)	L (mm)	 (g)	 (pce.)	
90Nm		25	208	206	1	*1
95Nm		25	202	200	1	*1
100Nm		25	196	198	1	*1
110Nm		25	213	220	1	*1
120Nm		25	201	219	1	*1
130Nm		25	205	225	1	*1
140Nm		25	205	230	1	*1
150Nm		25	195	250	1	*1
170Nm		25	195	257	1	*1

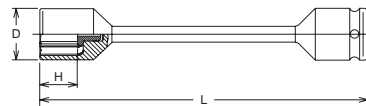

*1 C-Ring=C41, Pin/O-Ring=A41/B41 → P256-257

14101M  Torsion Bars (for tightening only)
Torsionsstäbe (nur zum Anziehen) 
Barres de torsion (pour serrage seulement)





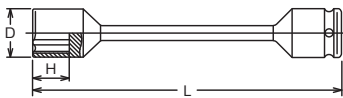

14101M (mmxNm)		D (mm)	H (mm)	L (mm)	 (g)	 (pce.)	
17x 60Nm		24	16	216	227	1	*1
17x 75Nm		24	16	228	240	1	*1
17x 95Nm		24	16	214	256	1	*1
17x110Nm		24	16	204	285	1	*1
17x120Nm		24	16	203	284	1	*1
19x 60Nm		26	18	219	237	1	*1
19x 90Nm		26	18	259	275	1	*1
19x110Nm		26	18	214	278	1	*1
19x120Nm		26	18	204	297	1	*1
19x135Nm		26	18	204	339	1	*1
19x170Nm		26	18	193	332	1	*1
21x100Nm		28	22	216	288	1	*1
21x120Nm		28	22	205	288	1	*1
22x160Nm		29	22	210	385	1	*1

*1 C-Ring=C41, Pin/O-Ring=A41/B41 → P256-257

16101M 
18101M  Torsion Bars (for tightening only)
Torsionsstäbe (nur zum Anziehen) 
Barres de torsion (pour serrage seulement)







16101M (mmxNm)		D (mm)	H (mm)	L (mm)	 (g)	 (pce.)	
24x180Nm		38.8	24	235	850	1	*1
27x450Nm		42.5	27	280	1236	1	*1
32x600Nm		48.8	32	280	1370	1	*1
33x600Nm		50	33	280	1370	1	*1

*1 C-Ring=C61, Pin/O-Ring=A61/B61 → P256-257

 As the torque could vary with the type and the condition of the impact wrench, we strongly recommend the control with a torque wrench.

Da die Drehmomentwerte von Art und Leistung des verwendeten Schlagschraubers abhängen, empfehlen wir die Kontrolle der Kombination Schlagschrauber/Torsionsstab mittels eines Drehmomentschlüssels.

Etant donné que le couple peut varier selon modèle, la capacité ou l'état de la clé à choc, le contrôle de la combinaison clé à choc/barre par clé dynamométrique est indispensable.

18101M (mmxNm)		D (mm)	H (mm)	L (mm)	 (g)	 (pce.)	
24x350Nm		43.5	24	300	1380	1	*1
27x350Nm		47	27	300	1401	1	*1
27x450Nm		47	27	300	1579	1	*1
30x500Nm		51	30	300	1563	1	*1
32x450Nm		53.5	32	300	1600	1	*1
32x550Nm		53.5	32	300	1602	1	*1
32x600Nm		53.5	32	300	1602	1	*1
32x700Nm		51.5	32	300	1630	1	*1
33x550Nm		55	33	300	1638	1	*1
33x600Nm		55	33	300	1638	1	*1
36x600Nm		58.5	36	300	1718	1	*1

*1 C-Ring=C81, Pin/O-Ring=A81/B81 → P256-257

Z-SERIES
 HAND
 TITANIUM
 SCREWDRIVERS ACCESSORIES
 IMPACT
 SLEEVE-DRIVE
 PROTECTOR
 INDUSTRIAL
 AUTOMOTIVE
 MOTORCYCLE
 CONSTRUCTION
 SPARE PART

6102M-400 8102M-400

Extra long socket for wheel nuts
 Extra lange Steckschlüssel für Radmuttern
 Douilles extra-longues pour écrous de roue

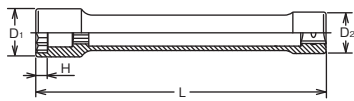

6102M-400 (mm)	□	D ₁ (mm)	D ₂ (mm)	H (mm)	L (mm)	⚖️ (g)	📦 (pce.)
41Wx21W	3/4"	58	40	14	400	1880	1
32		48.5	40	32	400	1480	1
33		49.8	40	32	400	1500	1

8102M-400 (mm)	□	D ₁ (mm)	D ₂ (mm)	H (mm)	L (mm)	⚖️ (g)	📦 (pce.)
41Wx21W	1"	58	49.9	14	400	2610	1
32		48.5	49.9	32	400	2210	1
33		49.8	49.9	32	400	2220	1

⚠️ 6102M/8102M are for hand use only. Do not use with a power tools.



Combination type
41Wx21W

Extra long Socket for wheel nut

16102M-270 / -400 18102M-270 / -400

Extra long Sockets for wheel Nuts
 Extra lange Steckschlüssel für Radmuttern
 Douilles extra-longues pour écrous de roue

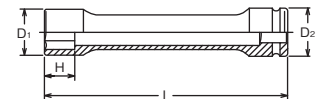

16102M-270 (mm)	□	D ₁ (mm)	D ₂ (mm)	H (mm)	L (mm)	⚖️ (g)	📦 (pce.)	⚡
24	3/4"	38.8	44	24	270	1034	1	*1
27		42.5	44	27	270	1088	1	*1
30		46.3	44	30	270	1144	1	*1
32		48.8	44	32	270	1157	1	*1
33		50	44	32	270	1200	1	*1
36		53.8	44	32	270	1250	1	*1
38		56.3	44	32	270	1610	1	*1
41		60	44	32	270	1640	1	*1

*1 C-Ring=C61, Pin/O-Ring=A61/B61 → P256-257

16102M-400 (mm)	□	D ₁ (mm)	D ₂ (mm)	H (mm)	L (mm)	⚖️ (g)	📦 (pce.)	⚡
24	3/4"	38.8	44	24	400	1430	1	*1
27		42.5	44	27	400	1460	1	*1
30		46.3	44	30	400	1510	1	*1
32		48.8	44	32	400	1530	1	*1
33		50	44	32	400	1530	1	*1
36		53.8	44	32	400	2180	1	*1

*1 C-Ring=C61, Pin/O-Ring=A61/B61 → P256-257

18102M-270 (mm)	□	D ₁ (mm)	D ₂ (mm)	H (mm)	L (mm)	⚖️ (g)	📦 (pce.)	⚡
23	1"	37.3	54	23	270	1627	1	*1
24		38.5	54	24	270	1628	1	*1
26		41	54	26	270	1667	1	*1
27		42.3	54	27	270	1680	1	*1
29		44.8	54	29	270	1680	1	*1
30		46	54	30	270	1680	1	*1
32		48.5	54	32	270	1680	1	*1
33		49.8	54	32	270	1700	1	*1
34		51	54	32	270	1750	1	*1
36		53.5	54	32	270	1750	1	*1
38		56	54	32	270	1822	1	*1
41		60	54	32	270	1800	1	*1

*1 C-Ring=C81, Pin/O-Ring=A81/B81 → P256-257

18102M-400 (mm)	□	D ₁ (mm)	D ₂ (mm)	H (mm)	L (mm)	⚖️ (g)	📦 (pce.)	⚡
23	1"	37.3	54	23	400	1865	1	*1
24		38.5	54	24	400	1869	1	*1
26		41	54	26	400	1925	1	*1
27		42.3	54	27	400	2272	1	*1
29		44.8	54	29	400	2278	1	*1
30		46	54	30	400	2266	1	*1
32		48.5	54	32	400	2322	1	*1
33		49.8	54	32	400	2320	1	*1
34		51	54	32	400	2341	1	*1
36		53.5	54	32	400	2442	1	*1
38		56	54	32	400	2550	1	*1

*1 C-Ring=C81, Pin/O-Ring=A81/B81 → P256-257

PW6P (mmxmm)	D ₁ (mm)	D ₂ (mm)	H (mm)	L (mm)	Shaft Color	(g)	(pcs.)	Ⓢ
32x17	47	44	12	75	Orange	621	2	*1
35x17	50	44	12	75	White	655	2	*1
38x20	55	44	12	75	Red	705	2	*1
41x19	58	44	12.5	80	Green	813	2	*1
41x20	58	44	12.5	80	Blue	813	2	*1
41x21	58	44	12.5	80	Yellow	779	2	*1

*1 C-Ring=C61, Pin/O-Ring=A61/B61 → P256-257

PW8P (mmxmm)	D ₁ (mm)	D ₂ (mm)	H (mm)	L (mm)	Shaft Color	(g)	(pcs.)	Ⓢ
35x17	50	54	12	83	White	867	2	*1
38x20	55	54	12	83	Red	941	2	*1
41x19	58	54	12.5	87	Green	1033	2	*1
41x20	58	54	12.5	87	Blue	1033	2	*1
41x21	58	54	12.5	87	Yellow	997	2	*1

*1 C-Ring=C81, Pin/O-Ring=A81/B81 → P256-257

**PW6P
PW8P**  Rear Wheel Nut Sockets
Steckschlüssel für Hinterradmuttern
Douilles spéciales pour écrous de roué arrière

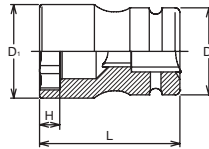

Tightening / Loosening Outer Nut

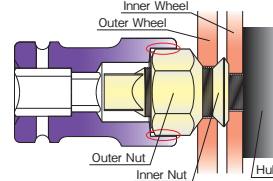

Tightening / Loosening Inner Nut

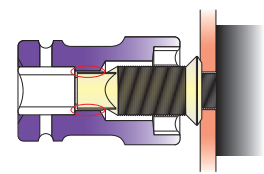

PW8P/4 4 Pieces Set/⚖️=4,250g

CARDBOARD BOX:W240xH95xT70mm

Sockets

 **PW8P** Impact Rear Wheel Nut Sockets
35x17, 38x20, 41x19, 41x21

PW8P (mmxmm)	□	D ₁ (mm)	D ₂ (mm)	H (mm)	L (mm)	(g)	Shaft Colour	(pcs.)	Ⓢ
35x17		50	54	13	83	935	White	5	*1
38x20	1"	55	54	14	83	1038	Red	5	*1
41x19		58	54	14	87	1100	Green	5	*1
41x21		58	54	14	87	1089	Yellow	5	*1

*1 C-Ring=C81, Pin/O-Ring=A81/B81 → P256-257

**PW8P/4
PW8P**  Socket set of Rear Wheel Nut Sockets
Steckschlüssel für Hinterradmuttern, im Satz
Jeu de douilles spéciales pour écrous de roué arrière



PW8L (mmxmm)	□	D ₁ (mm)	D ₂ (mm)	H (mm)	L (mm)	(g)	(pcs.)	Ⓢ
41x21	1"	58	54	15	105	1263	1	*1

*1 C-Ring=C81, Pin/O-Ring=A81/B81 → P256-257

PW8L  Rear Wheel Nut Socket (long)
Steckschlüssel für Hinterradmuttern, lang
Douilles spéciales pour écrous de roué arrière longue

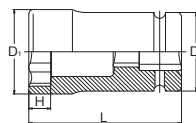

PS6 (mm)	□	D ₁ (mm)	D ₂ (mm)	H (mm)	L (mm)	(g)	(pcs.)	Ⓢ
17		40	44	19	53	433	5	*1
19	3/4"	40	44	19	53	419	5	*1
20		44	44	21	55	483	5	*1
21		44	44	23	60	491	5	*1

*1 C-Ring=C61, Pin/O-Ring=A61/B61 → P256-257

**PS6
PS8**  Rear Wheel Nut Sockets
Steckschlüssel für Hinterradmuttern
Douilles spéciales pour écrous de roué arrière

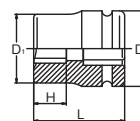

PS8 (mm)	□	D ₁ (mm)	D ₂ (mm)	H (mm)	L (mm)	(g)	(pcs.)	Ⓢ
17		40	54	19	60	621	2	*1
19	1"	43	54	19	60	648	2	*1
20		45	54	21	62	687	2	*1
21		45	54	23	64	696	2	*1

*1 C-Ring=C81, Pin/O-Ring=A81/B81 → P256-257

Z-SERIES
 HAND
 TITANIUM
 SCREWDRIVERS ACCESSORIES
 IMPACT
 SLEEVE-DRIVE
 PROTECTOR
 INDUSTRIAL
 AUTOMOTIVE
 MOTORCYCLE
 CONSTRUCTION
 SPARE PART

14466A-200B 14488A-B / -200B

Adaptor
Verbindungsstück
Réducteur

No Warranty
Keine Garantie
Sans Garantie



	□ (sq)	□ (sq)	L (mm)	⚖ (g)	📦 (pce.)	⚡
14466A-200B	1/2"	3/4"	200	560	1	*2
14488A-B	1/2"	1"	58	280	1	*2
14488A-200B	1/2"	1"	200	660	1	*2

*2 C-Ring=C42, Pin/O-Ring=A42/B42 → P256-257

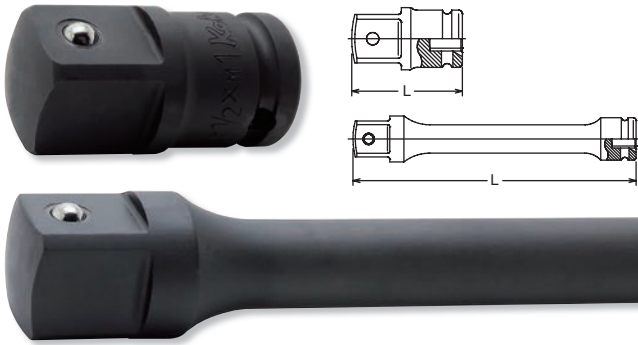

(PW8P-41X21 + 14488A-200B + 1/2" SQ. Impact wrench)

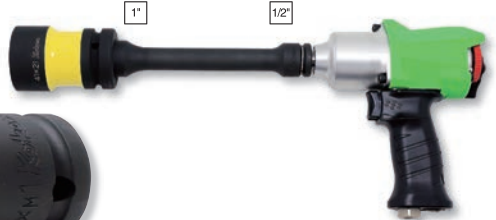

14466A-B / 14488A-B Impact Adaptors (□1/2" SQ. → □3/4", 1" SQ.)

For temporary fastening a wheel nut socket for large vehicle with a light duty 1/2" SQ. DR. Impact wrench.

 Socket is not completely locked with the Ball-type adaptor connection. Please beware of accidental socket release.

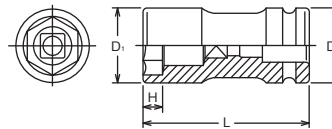

16316M / 16316A 18316M / 18316A

Rear Wheel Nut Sockets
Steckschlüssel für Hinterradmuttern
Douilles spéciales pour écrous de roué arrière



16316M (mmxmm)	□	D ₁ (mm)	D ₂ (mm)	H (mm)	L (mm)	⚖ (g)	📦 (pce.)	⚡
35x17	3/4"	52	44	10	90	865	1	*1
38x20		56	44	13	100	952	1	*1
41x19		59	44	12	100	1037	1	*1
41x21		59	44	15	100	963	1	*1

*1 C-Ring=C61, Pin/O-Ring=A61/B61 → P256-257

18316M (mmxmm)	□	D ₁ (mm)	D ₂ (mm)	H (mm)	L (mm)	⚖ (g)	📦 (pce.)	⚡
35x17	1"	52	54	10	108	1153	1	*1
38x20		56	54	13	108	1133	1	*1
41x19		59	54	12	108	1200	1	*1
41x21		59	54	15	108	1155	1	*1

*1 C-Ring=C81, Pin/O-Ring=A81/B81 → P256-257

16316A (inchxinch)	□	D ₁ (mm)	D ₂ (mm)	H (mm)	L (mm)	⚖ (g)	📦 (pce.)	⚡
1.1/2x13/16	3/4"	56	44	13	100	940	1	*1

*1 C-Ring=C61, Pin/O-Ring=A61/B61 → P256-257

18316A (inchxinch)	□	D ₁ (mm)	D ₂ (mm)	H (mm)	L (mm)	⚖ (g)	📦 (pce.)	⚡
1.1/2x13/16	1"	59	54	13	108	1120	1	*1

*1 C-Ring=C81, Pin/O-Ring=A81/B81 → P256-257

16317M / 16317A 18317M / 18317A

Rear Wheel Nut Sockets
Steckschlüssel für Hinterradmuttern
Douilles spéciales pour écrous de roué arrière

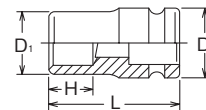

16317M (mm)	□	D ₁ (mm)	D ₂ (mm)	H (mm)	L (mm)	⚖ (g)	📦 (pce.)	⚡
17	3/4"	40	44	22.5	67	485	1	*1
19		40	44	22.5	67	462	1	*1
20		44	44	22.5	67	517	1	*1
21		44	44	22.5	67	489	1	*1
22		44	44	22.5	67	482	1	*1

*1 C-Ring=C61, Pin/O-Ring=A61/B61 → P256-257

18317M (mm)	□	D ₁ (mm)	D ₂ (mm)	H (mm)	L (mm)	⚖ (g)	📦 (pce.)	⚡
17	1"	40	54	22.5	72	682	1	*1
17.5		40	54	22.5	72	677	1	*1
19		43	54	22.5	72	705	1	*1
20		45	54	22.5	72	723	1	*1
20.5		45	54	22.5	72	723	1	*1
21		45	54	22.5	72	703	1	*1
22		45	54	22.5	72	696	1	*1

*1 C-Ring=C81, Pin/O-Ring=A81/B81 → P256-257

16317A (inch)	□	D ₁ (mm)	D ₂ (mm)	H (mm)	L (mm)	⚖ (g)	📦 (pce.)	⚡
13/16	3/4"	44	44	22.5	67	489	1	*1

*1 C-Ring=C61, Pin/O-Ring=A61/B61 → P256-257

18317A (inch)	□	D ₁ (mm)	D ₂ (mm)	H (mm)	L (mm)	⚖ (g)	📦 (pce.)	⚡
13/16	1"	45	54	22.5	72	703	1	*1

*1 C-Ring=C81, Pin/O-Ring=A81/B81 → P256-257